

# M62203FP

## 3.3 V, 2.7 V Two-Channel Fixed-Output General-Purpose DC-DC Converter

REJ03F0094-0100Z

Rev.1.0

Sep.19.2003

### Description

The M62203FP is an integrated circuit developed as a two-channel (3.3 V and 2.7 V) fixed-output general-purpose DC-DC converter.

Peripheral elements are incorporated in a small 8-pin package, enabling peripheral circuitry to be simplified, and compact, low-cost set design to be achieved.

In addition, the M62203FP has an on-chip reset circuit that monitors power supply voltage VCC (5 V) and output voltage Vout (3.3 V), enabling erroneous system operation to be prevented.

### Features

- Wide operating power supply voltage range: 4 to 15 V (5 V Typ.)
- Low current dissipation: 1.0 mA (VCC = 5 V, no load)
- On-chip 5 V, 3.3 V dual voltage system detection reset circuitry
- On-chip oscillation circuit not requiring peripheral elements (110 kHz Typ.)
- 8-pin SOP package

### Applications

General electronic products such as mobile and portable devices

### Pin Configuration (Top View)



Block Diagram

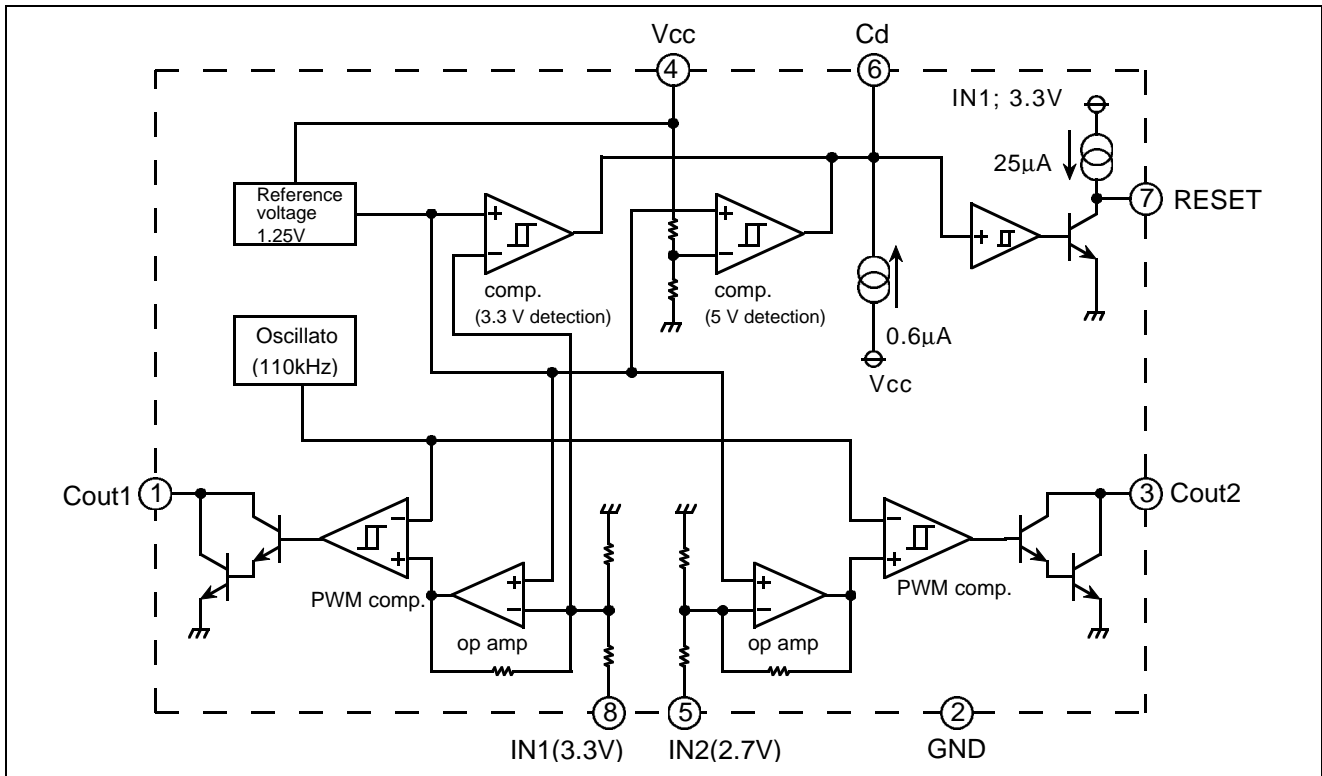

Absolute Maximum Ratings

Unless specified otherwise noted, Ta = 25°C

Item	Symbol	Ratings	Unit	Conditions
Power supply voltage	Vcc	16	V	
DC-DC converter block output drive current	Io	30	mA	ch1, ch2
Reset circuit block output inflow current	IoRESET	6	mA	
Internal power consumption	Pd	440	mW	Ta = 25°C
Thermal reduction ratio	Kθ	4.4	mW/°C	Ta > 25°C
Operating ambient temperature	Topr	-20 to +85	°C	
Storage temperature	Tstg	-40 to +125	°C	

## Electrical Characteristics

(Unless specified otherwise noted, VCC = 5 V, Ta = 25°C)

Block	Item	Symbol	Limits			Unit	Test Conditions
			Min.	Typ.	Max.		
All blocks	Power supply voltage range	Vcc	4.0	5.0	15	V	
	Current dissipation	Icc	—	1.0	1.5	mA	No output load
DC-DC converter block							
Error amp	Output voltage	Vo1	3.15	3.30	3.45	V	Ch1 output
		Vo2	2.57	2.70	2.83		Ch2 output
	Line regulation	Vreg-L	—	5	15	mV	
	Input current 1	Iin	—	150	450	μA	
	Input current 2	Iin	—	100	300	μA	
Oscillator	Oscillation frequency	fosc	65	110	160	KHz	
Output	Maximum on-duty	TDUTY	—	90	—	%	
	Output leakage current	ICL	-1	—	1	V	
	Output saturation voltage	Vsat	—	1.2	2.0	V	Io = 10 mA, Darlington connection type
Reset block							
Reset circuit	Detection voltage 1	Vs1	3.8	4.0	4.2	mV	VCC = 5 V detection
	Hysteresis voltage 1	ΔVs1	30	50	80	V	
	Detection voltage 2	Vs2	2.57	2.70	2.83	mV	Ch1 output (3.3 V) detection
	Hysteresis voltage 2	ΔVs2	30	50	80	μA	
	Delay constant current	IPD	-1.1	-0.6	-0.3	msec	
	Delay time	tpd	5	10	20	μA	Cd = 4700pF
	Output constant current	IOC	-40	-25	-17	μA	Vcc = 5V, Vo = 1/2 × Vcc
	Output low voltage	VOL	—	—	0.2Vo1	V	IoRESET = 4mA
Output high voltage	VOH	0.8Vo1	—	—	V		

Electrical Characteristic Curves

Thermal Reduction Curve (Maximum Rating)

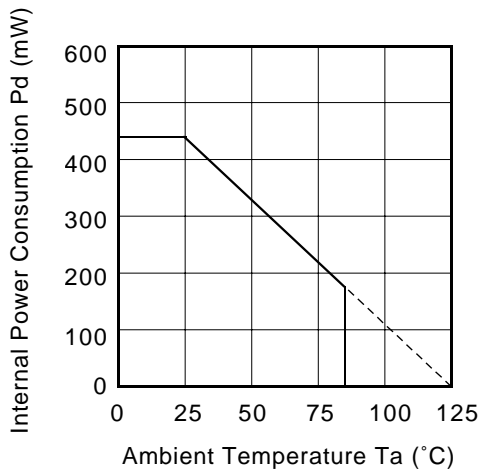

Circuit Current - Power Supply Voltage Characteristic

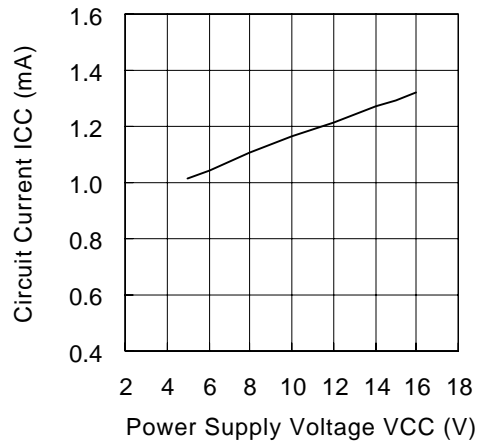

Output Voltage 1 - Power Supply Voltage Characteristic

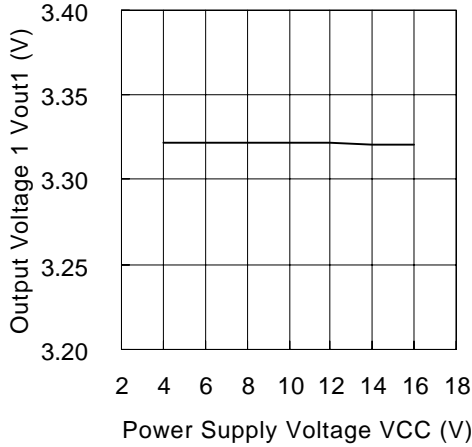

Output Voltage 2 - Power Supply Voltage Characteristic

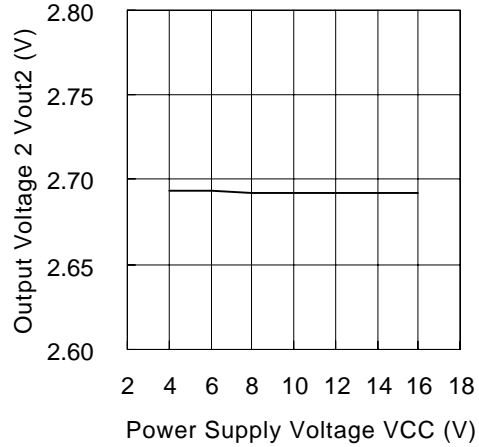

IN1 Pin Input Current - Power Supply Voltage Characteristic

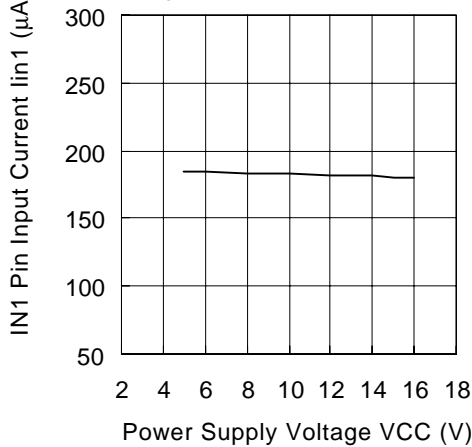

IN2 Pin Input Current - Power Supply Voltage Characteristic

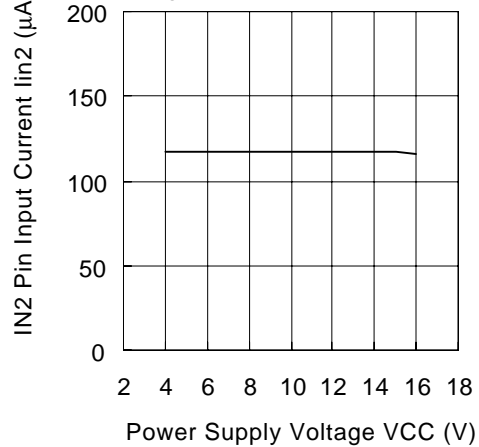

Oscillation Frequency - Power Supply Voltage Characteristic

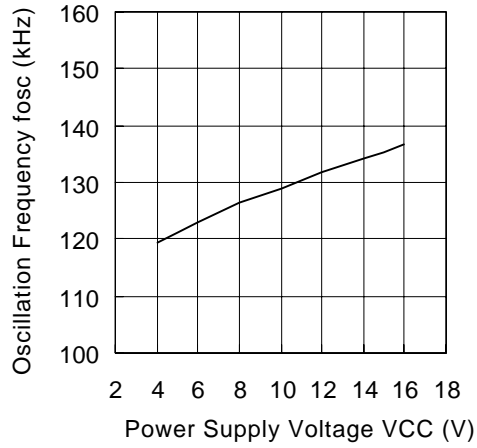

Maximum On-Duty 1 - Power Supply Voltage Characteristic

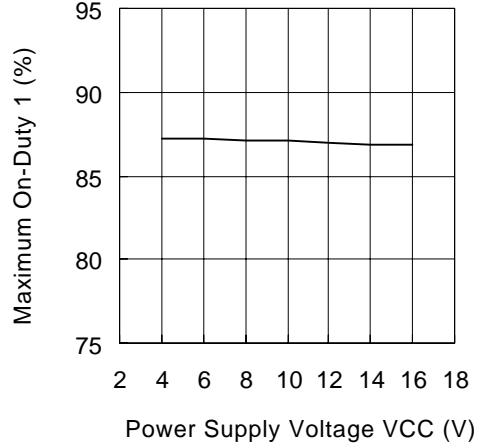

Maximum On-Duty 2 - Power Supply Voltage Characteristic

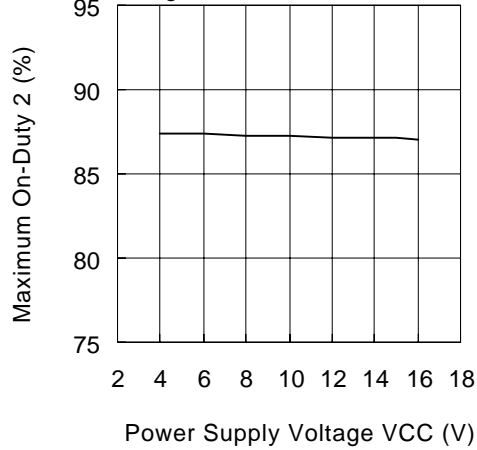

Detection Voltage 2 - Power Supply Voltage Characteristic

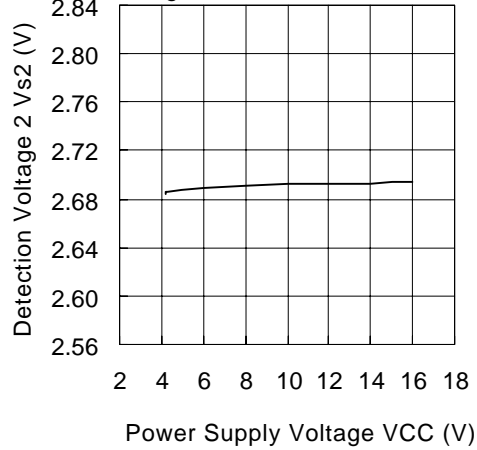

Hysteresis Voltage 2 - Power Supply Voltage Characteristic

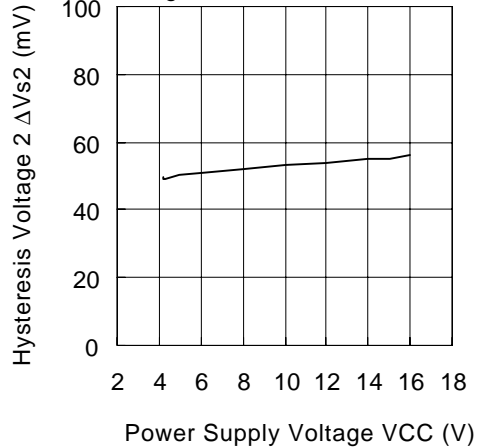

Cd Pin Outflow Current - Power Supply Voltage Characteristic

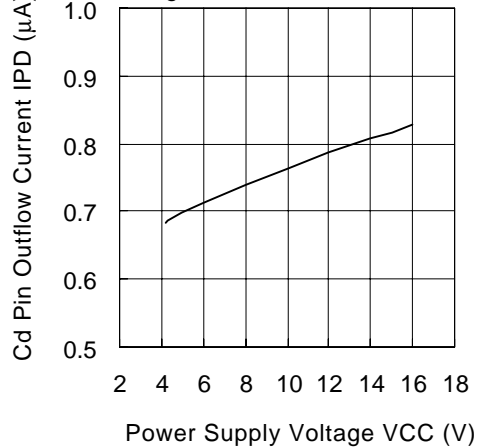

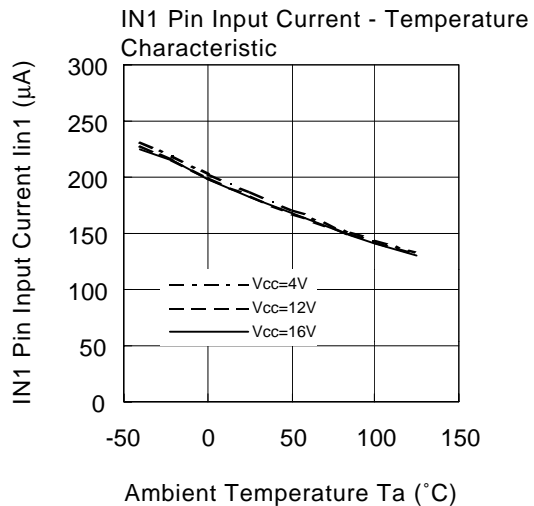
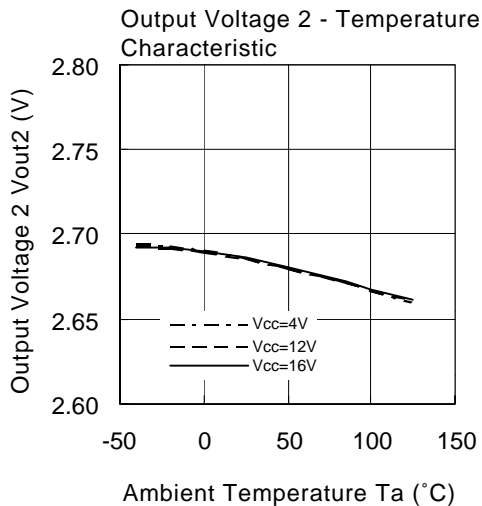
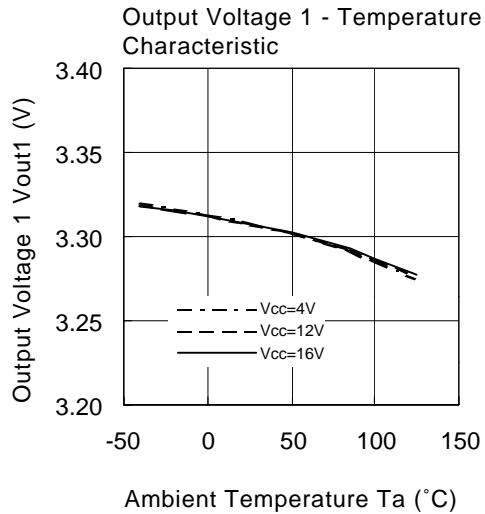
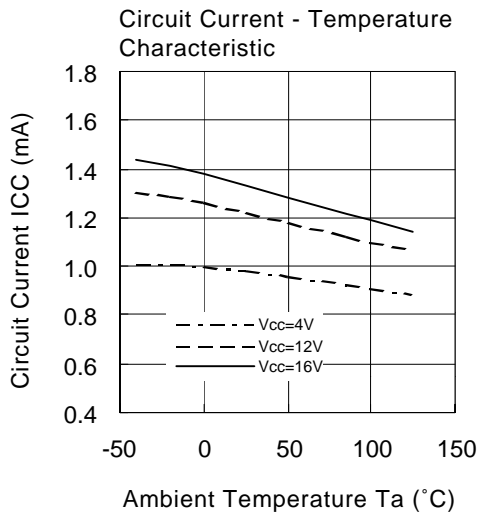
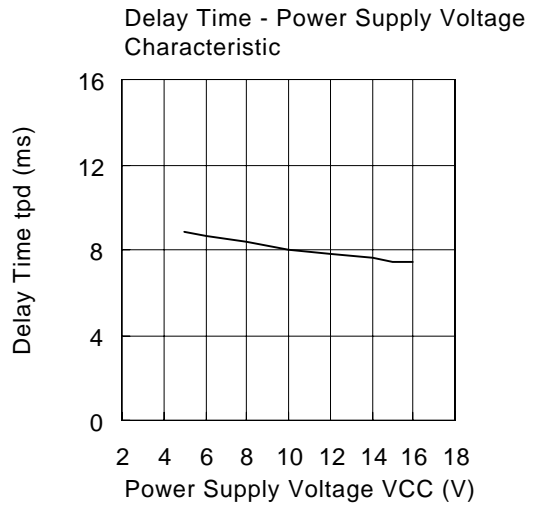
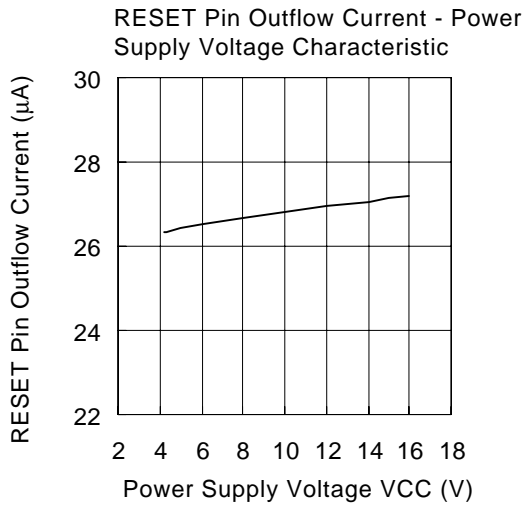

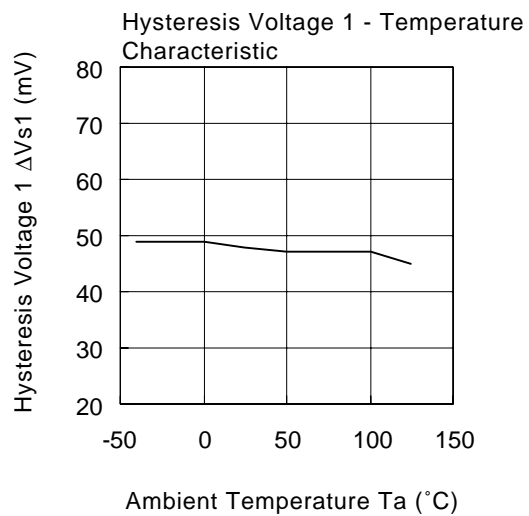
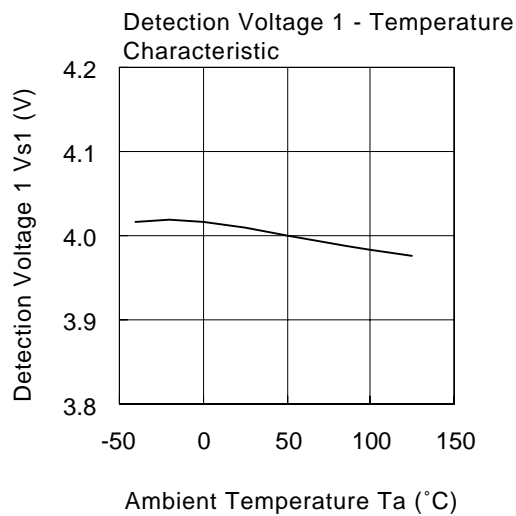
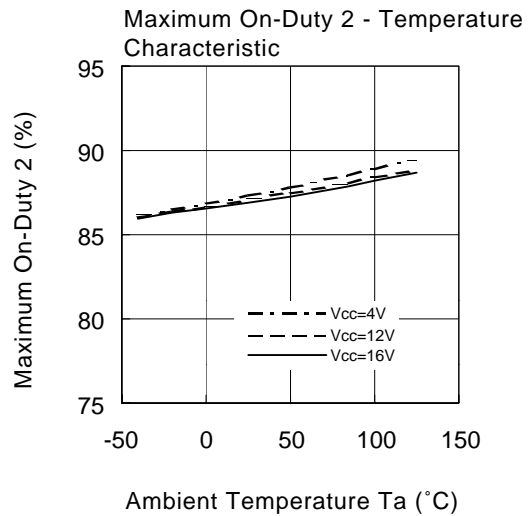
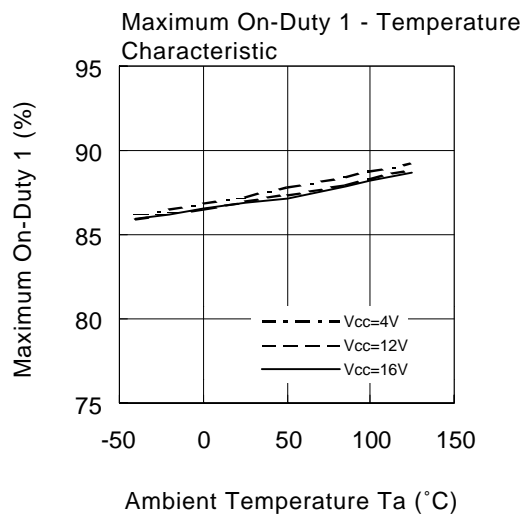
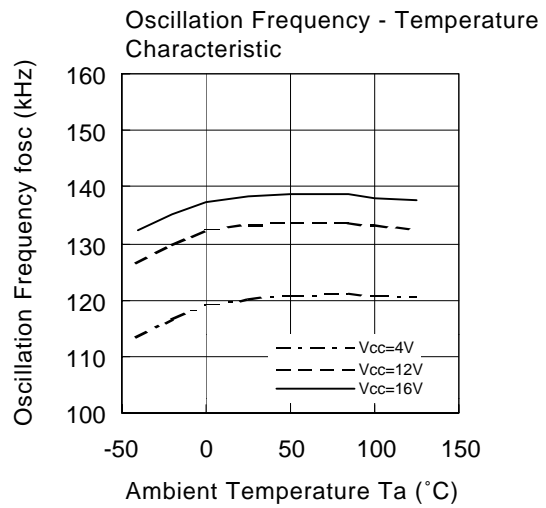
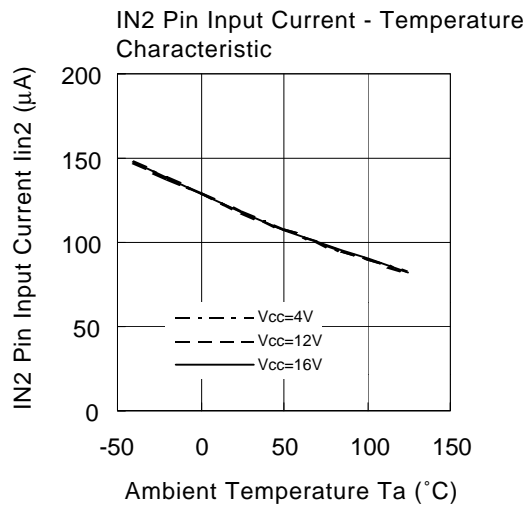

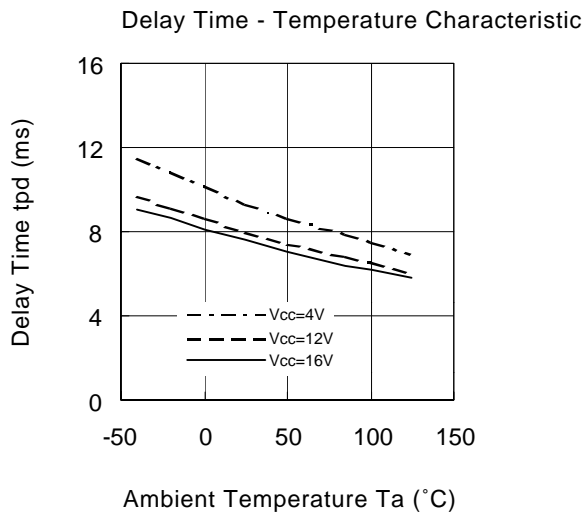
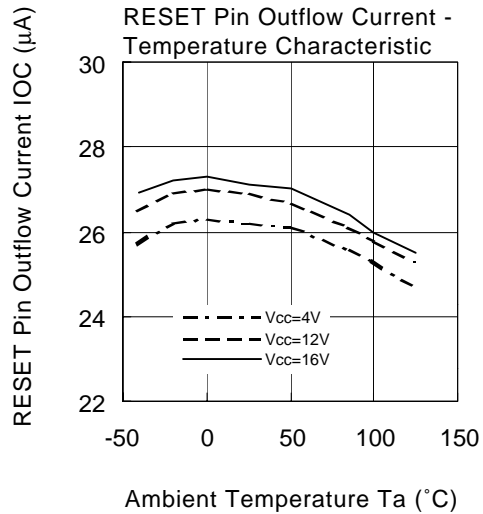
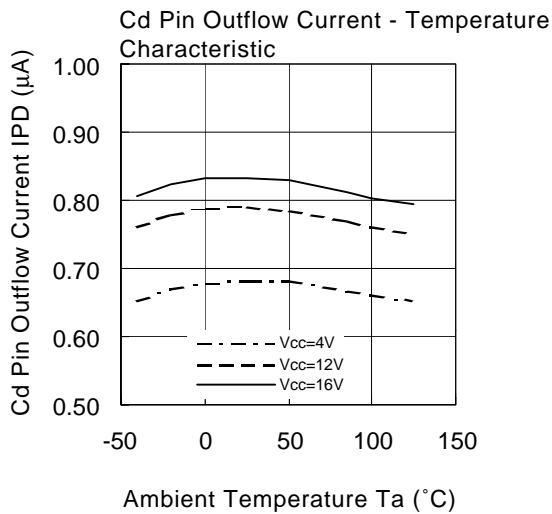
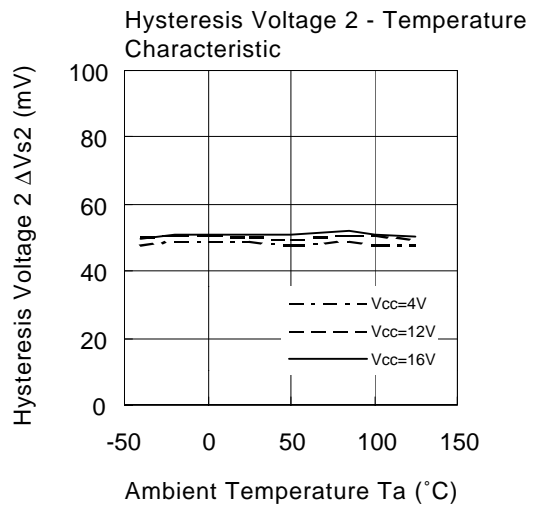
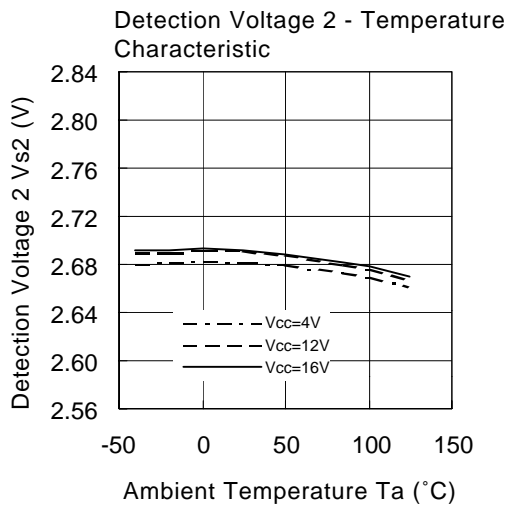



## Reset Circuit Operation

Reset Circuit Block Timing Chart

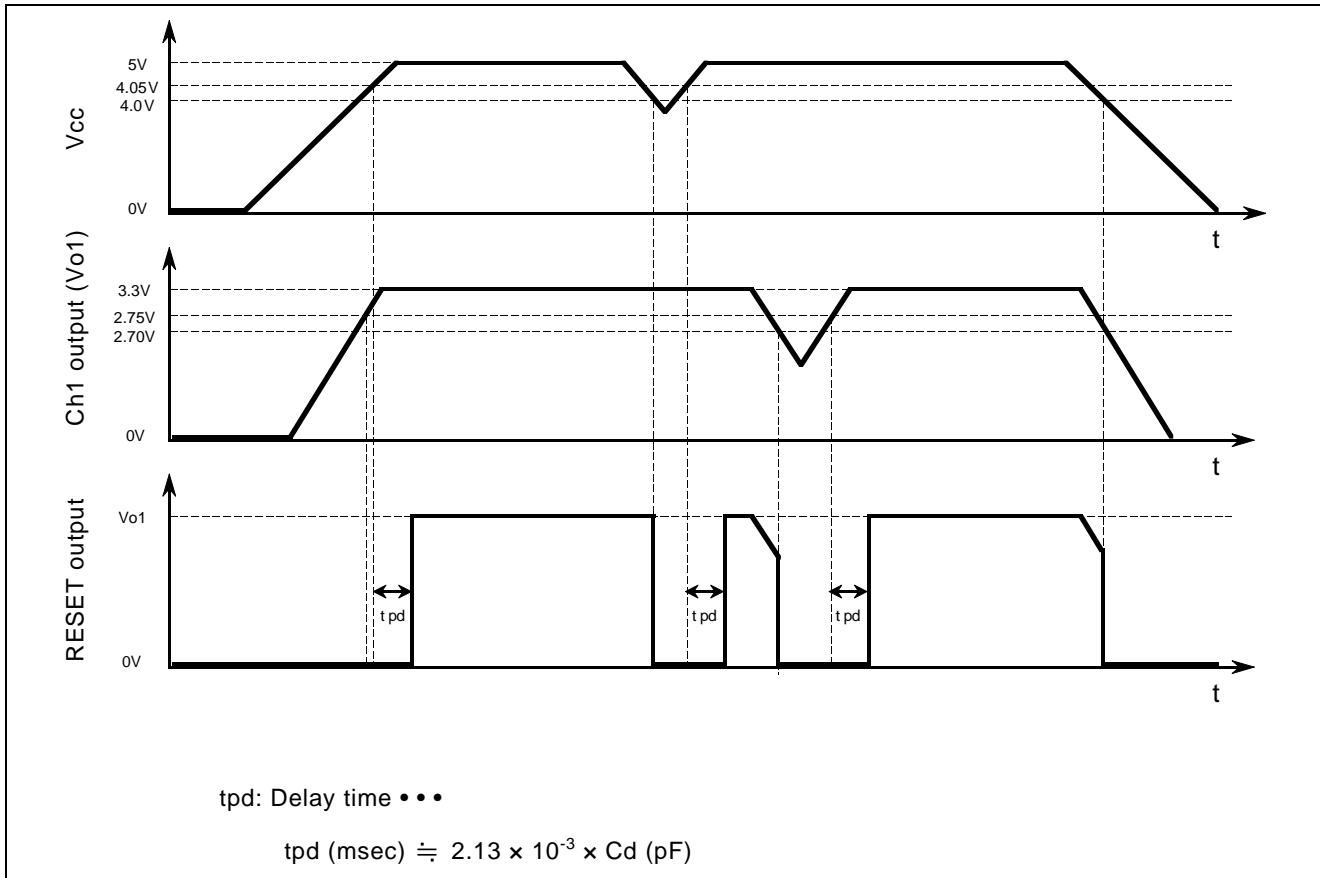

Application Example (3.3 V, 2.7 V Dual-Output DC-DC Converter)

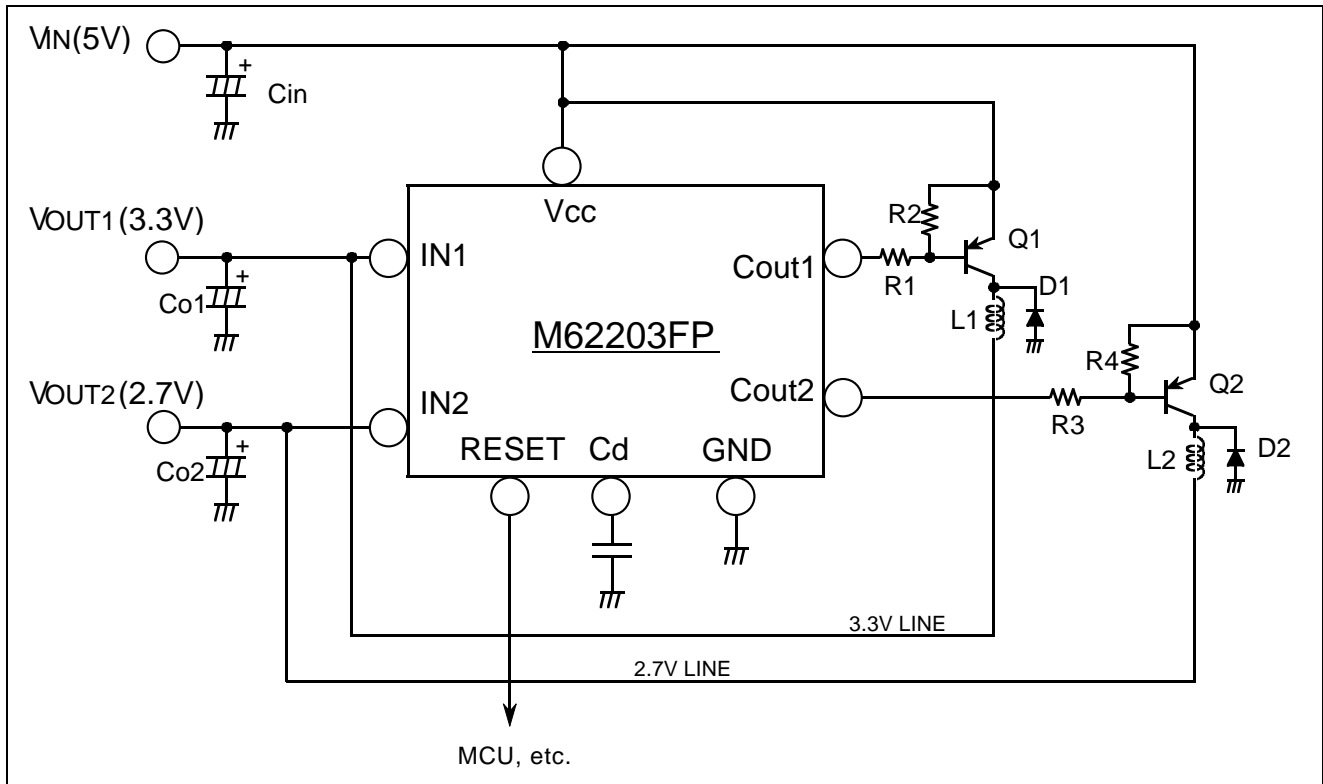

Constant Determination Equations

Constant	Calculation Equation
$\frac{T_{ON}}{T_{OFF}}$	$\frac{V_O + V_F}{V_{IN} - V_{CE(sat)} - V_O}$
$(T_{ON} + T_{OFF})_{MAX}$	$\frac{1}{f_{osc}}$ fosc: 110KHz (Vcc=5V)
$T_{OFF(MIN)}$	$(T_{ON} + T_{OFF}) / (1 + \frac{T_{ON}}{T_{OFF}})$
$T_{ON(MAX)}$	$\frac{1}{f_{osc}} - T_{OFF}$
$L(MIN)$	$\frac{(V_{IN} - V_{CE(sat)} - V_O) \times T_{ON(MAX)}}{\Delta I_o}$
$I_{pk}$	$I_o + \frac{1}{2} \Delta I_o$

- Notes:
- VF: Forward voltage of external diode
  - V<sub>sat</sub>: Output saturation voltage of external transistor
  - ΔI<sub>o</sub>: Set to 1/5 to 1/3 of the maximum load current.
  - Use an external transistor Tr., diode D, and inductor L with a current rating of I<sub>pk</sub> or above.

Package Dimensions

**8P2S-A**

(MMP)

EIAJ Package Code SOP8-P-225-1.27	JEDEC Code -	Weight(g) 0.07	Lead Material Cu Alloy
--------------------------------------	-----------------	-------------------	---------------------------

**Plastic 8pin 225mil SOP**

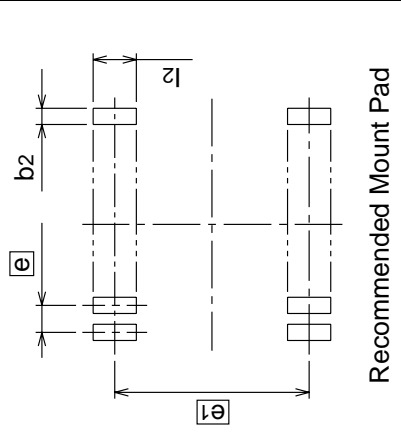

Recommended Mount Pad

Symbol	Dimension in Millimeters		
	Min	Nom	Max
A	-	-	1.9
A1	0.05	-	-
A2	-	1.5	-
b	0.35	0.4	0.5
c	0.13	0.15	0.2
D	4.8	5.0	5.2
E	4.2	4.4	4.6
e	-	1.27	-
HE	5.9	6.2	6.5
L	0.2	0.4	0.6
L1	-	0.9	-
Z	-	0.595	-
Z1	-	-	0.745
x	-	-	0.25
y	-	-	0.1
$\theta$	0°	-	10°
b2	-	0.76	-
e1	-	5.72	-
l2	1.27	-	-

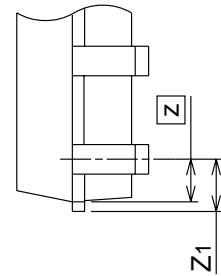
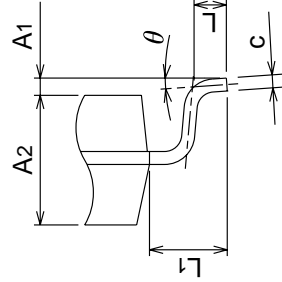
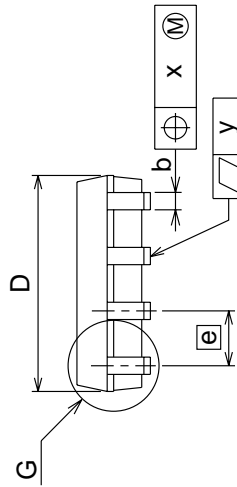
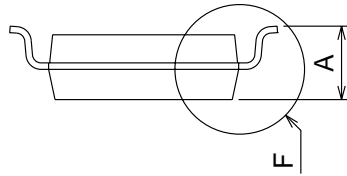
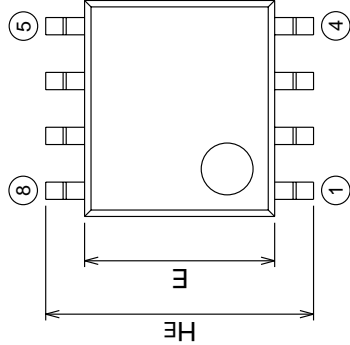

## Renesas Technology Corp. Sales Strategic Planning Div. Nippon Bldg., 2-6-2, Ohte-machi, Chiyoda-ku, Tokyo 100-0004, Japan

---

Keep safety first in your circuit designs!

1. Renesas Technology Corp. puts the maximum effort into making semiconductor products better and more reliable, but there is always the possibility that trouble may occur with them. Trouble with semiconductors may lead to personal injury, fire or property damage.  
Remember to give due consideration to safety when making your circuit designs, with appropriate measures such as (i) placement of substitutive, auxiliary circuits, (ii) use of nonflammable material or (iii) prevention against any malfunction or mishap.

Notes regarding these materials

1. These materials are intended as a reference to assist our customers in the selection of the Renesas Technology Corp. product best suited to the customer's application; they do not convey any license under any intellectual property rights, or any other rights, belonging to Renesas Technology Corp. or a third party.
  2. Renesas Technology Corp. assumes no responsibility for any damage, or infringement of any third-party's rights, originating in the use of any product data, diagrams, charts, programs, algorithms, or circuit application examples contained in these materials.
  3. All information contained in these materials, including product data, diagrams, charts, programs and algorithms represents information on products at the time of publication of these materials, and are subject to change by Renesas Technology Corp. without notice due to product improvements or other reasons. It is therefore recommended that customers contact Renesas Technology Corp. or an authorized Renesas Technology Corp. product distributor for the latest product information before purchasing a product listed herein.  
The information described here may contain technical inaccuracies or typographical errors.  
Renesas Technology Corp. assumes no responsibility for any damage, liability, or other loss rising from these inaccuracies or errors.  
Please also pay attention to information published by Renesas Technology Corp. by various means, including the Renesas Technology Corp. Semiconductor home page (<http://www.renesas.com>).
  4. When using any or all of the information contained in these materials, including product data, diagrams, charts, programs, and algorithms, please be sure to evaluate all information as a total system before making a final decision on the applicability of the information and products. Renesas Technology Corp. assumes no responsibility for any damage, liability or other loss resulting from the information contained herein.
  5. Renesas Technology Corp. semiconductors are not designed or manufactured for use in a device or system that is used under circumstances in which human life is potentially at stake. Please contact Renesas Technology Corp. or an authorized Renesas Technology Corp. product distributor when considering the use of a product contained herein for any specific purposes, such as apparatus or systems for transportation, vehicular, medical, aerospace, nuclear, or undersea repeater use.
  6. The prior written approval of Renesas Technology Corp. is necessary to reprint or reproduce in whole or in part these materials.
  7. If these products or technologies are subject to the Japanese export control restrictions, they must be exported under a license from the Japanese government and cannot be imported into a country other than the approved destination.  
Any diversion or reexport contrary to the export control laws and regulations of Japan and/or the country of destination is prohibited.
  8. Please contact Renesas Technology Corp. for further details on these materials or the products contained therein.
- 



### RENESAS SALES OFFICES

<http://www.renesas.com>

**Renesas Technology America, Inc.**  
450 Holger Way, San Jose, CA 95134-1368, U.S.A  
Tel: <1> (408) 382-7500 Fax: <1> (408) 382-7501

**Renesas Technology Europe Limited.**  
Dukes Meadow, Millboard Road, Bourne End, Buckinghamshire, SL8 5FH, United Kingdom  
Tel: <44> (1628) 585 100, Fax: <44> (1628) 585 900

**Renesas Technology Europe GmbH**  
Dornacher Str. 3, D-85622 Feldkirchen, Germany  
Tel: <49> (89) 380 70 0, Fax: <49> (89) 929 30 11

**Renesas Technology Hong Kong Ltd.**  
7/F., North Tower, World Finance Centre, Harbour City, Canton Road, Hong Kong  
Tel: <852> 2265-6688, Fax: <852> 2375-6836

**Renesas Technology Taiwan Co., Ltd.**  
FL 10, #99, Fu-Hsing N. Rd., Taipei, Taiwan  
Tel: <886> (2) 2715-2888, Fax: <886> (2) 2713-2999

**Renesas Technology (Shanghai) Co., Ltd.**  
26/F., Ruijin Building, No.205 Maoming Road (S), Shanghai 200020, China  
Tel: <86> (21) 6472-1001, Fax: <86> (21) 6415-2952

**Renesas Technology Singapore Pte. Ltd.**  
1, Harbour Front Avenue, #06-10, Keppel Bay Tower, Singapore 098632  
Tel: <65> 6213-0200, Fax: <65> 6278-8001